

| | | | |
|--|------------------------|--------------------------------|--|
| Revision Notes: | | | |
| 1. FRAME AND DIMENSIONS UPDATED. | | | |
| Checked By: LB | Approved By: DK | Date Released: 03/05/12 | |
| 2. GIFTBOX AND SERIAL NUMBER LABEL REFERENCE UPDATED, PACKAGING ADDED. | | | |
| Checked By: BC | Approved By: SM | Date Released: 12/11/12 | |

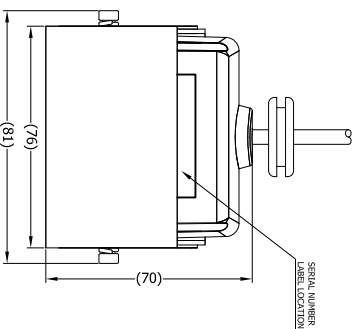

| ITEM | PART NO. | QTY | MODEL/DESCRIPTION |
|------|----------|-----|---|
| 1 | (328A) | 1 | VBV-701C CAMERA ONLY |
| 2 | (3190A) | 1 | VBV-701C CAMERA BRACKET |
| 3 | (3190A) | 1 | VBV-71XXX-SS CAMERA SHIELD |
| 4 | (3191) | 1 | VBV-71XXX-FIX CAMERA FIXING PACK |
| 5 | (3428) | 1 | VBV-7X1C1G INSTALLATION GUIDE (NOT SHOWN) |

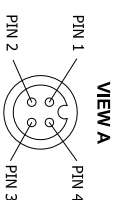
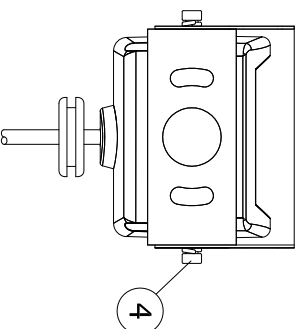
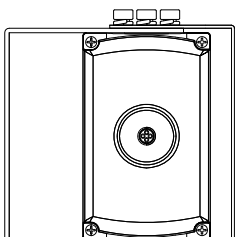
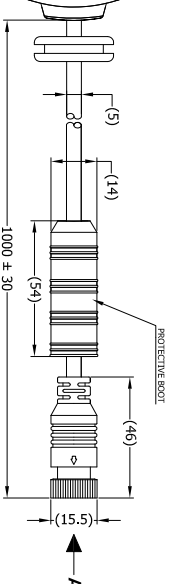
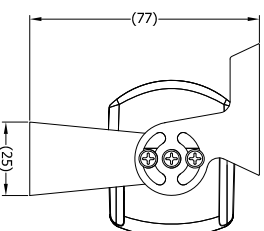
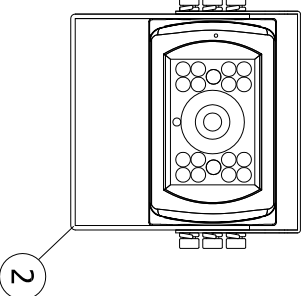
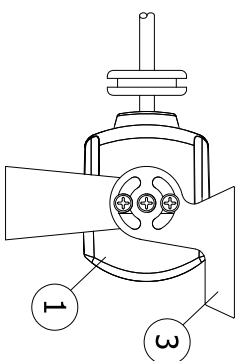
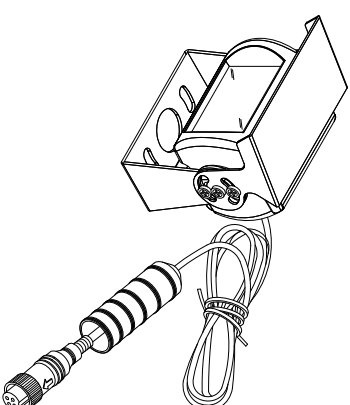

| PIN # | WIRE COLOUR | DESCRIPTION |
|-------|-------------|-------------|
| 1 | RED | 12 VDC |
| 2 | BLACK | GROUND |
| 3 | WHITE | AUDIO |
| 4 | YELLOW | VIDEO |

- NOTES:**
1. REFER TO PRODUCT SPECIFICATION FOR PRODUCT SPECIFICATIONS.
 2. REFER TO COMPONENT DRAWINGS FOR COMPONENT DETAILS
 3. FOR GIFTBOX LABEL REFER TO LATEST REVISION OF DRAWING BE-001168-XX-10.
 4. FOR GIFTBOX SERIAL NUMBER LABEL REFER TO LATEST REVISION OF DRAWING BE-001323-XX-10.
 5. PURCHASE ORDER TO DEFINE PACKAGING VARIANT.
 6. REFER TO LATEST REVISION OF DRAWING BE-001985-XX-12 FOR PACKAGING DETAIL.

PROPRIETARY NOTICE
 THIS DESIGN AND TECHNICAL INFORMATION APPEARING ON THIS DRAWING IS THE PROPERTY OF BRIGADE ELECTRONICS, AND IS DISCLOSED IN CONFIDENCE. IT IS NOT TO BE COPIED, REPRODUCED, REVEALED TO OR EXPLOITED BY OTHERS, EITHER IN WHOLE OR IN PART WITHOUT THE EXPRESS WRITTEN CONSENT OF BRIGADE ELECTRONICS.

BRIGADE
 www.brigade-electronics.com

| | | | | | | | |
|--|--|------------------------------|--|---------------------------------|--|---------------------------------|--|
| Assembly Pl Approval XINYU HUANG(12/11/12) | | Approved by DKERAI | | Checked by BCHILD | | Drawn by MBUTLER | |
| Angle of Projection | | Units mm | | Scale N/A | | Released 29/07/10 | |
| Status RELEASED | | Part No. 2575A | | Released 12/20/02/048 | | Assembly Ref VBV-701C | |
| | | | | | | BE-001166-02-10 | |